

MATCH 3 LIGHT SUSPENSION

D101469-

base number _____
 Finish Options _____

- To build a product code in our configurator select the specify button on the base model # product page
- To build a manual product code on this datasheet choose from the options listed below in blue font and add the suffix to the base model #

GENERAL

Series: Match
 Subseries: Match 3 Light
 Brand: Quasar
 Division: Design
 Mounting Type: Suspension
 Mounting Location: Ceiling
 Subcategory: Pendant

PHYSICAL

Shape: Rectangle
 Length (mm): 800
 Length (in): 31 1/2
 Width (mm): 80
 Width (in): 3 1/8
 Height (mm): 63
 Height (in): 2 1/2
 Max. Overall Height (mm): 2063
 Max. Overall Height (in): 81 1/4
 Light Distribution: Downlight
 Weight (kg): 3
 Weight (lbs): 6.61
 Diffuser: Acrylic - See Finish Options
 Fixture Finish: RED / ORG / YEL / GRN / LBL / TRA
 Fixture Material: Aluminum
 Cable Details: 2000mm Cable

ELECTRICAL

Lamp Type: LED
 Input Wattage (W): 12
 Total Output Wattage (W): 9.3
 Dimming: Phase Dimming (120Vac Only)
 Driver Included: Yes
 Driver Location: Integrated
 Driver Type: Constant Current - Universal
 Driver Class: Class 2
 Input Voltage (V): 120 - 277
 Constant Current (MA): 350
 Upon Request: (Not included - see components) Integral: Phase dimming @120Vac only

LED

Number of LEDs: 3
 Color Temperature (°K): 2700
 Max. Delivered Lumen (lm): 825
 CRI: >90 CRI
 Lamp Life (hrs): 50000

OPTICAL

RATINGS AND CERTIFICATIONS

Certified By: Certified for North American Standards
 IP rating: IP20



MATCH 3 LIGHT SUSPENSION

D101469-

PROJECT _____

TYPE _____

SPECIFIER _____

QUANTITY _____

DATE _____



D

MATCH 4 LIGHT SUSPENSION

D101470-

base number _____
 Finish Options _____

- To build a product code in our configurator select the specify button on the base model # product page
- To build a manual product code on this datasheet choose from the options listed below in blue font and add the suffix to the base model #

GENERAL

Series: Match
 Subseries: Match 4 Light
 Brand: Quasar
 Division: Design
 Mounting Type: Suspension
 Mounting Location: Ceiling
 Subcategory: Pendant

PHYSICAL

Shape: Rectangle
 Length (mm): 800
 Length (in): 31 1/2"
 Width (mm): 80
 Width (in): 3 1/8"
 Height (mm): 63
 Height (in): 2 1/2"
 Max. Overall Height (mm): 2063
 Max. Overall Height (in): 81 1/4"
 Light Distribution: Downlight
 Weight (kg): 3
 Weight (lbs): 6.61
 Diffuser: Acrylic - See Finish Options
 Fixture Finish: RED / ORG / YEL / GRN / LBL / TRA
 Fixture Material: Aluminum
 Cable Details: 2000mm Cable

ELECTRICAL

Lamp Type: LED
 Input Wattage (W): 16
 Total Output Wattage (W): 12.4
 Dimming: Phase Dimming (120Vac Only)
 Driver Included: Yes
 Driver Location: Integrated
 Driver Type: Constant Current - Universal
 Driver Class: Class 2
 Input Voltage (V): 120 - 277
 Constant Current (MA): 350
 Upon Request: (Not included - see components) Integral: Phase dimming @120Vac only

LED

Number of LEDs: 4
 Color Temperature (°K): 2700
 Max. Delivered Lumen (lm): 1100
 CRI: >90 CRI
 Lamp Life (hrs): 50000

OPTICAL

RATINGS AND CERTIFICATIONS

Certified By: Certified for North American Standards
 IP rating: IP20



MATCH 4 LIGHT SUSPENSION

D101470-

PROJECT _____

TYPE _____

SPECIFIER _____

QUANTITY _____

DATE _____



D

MATCH 5 LIGHT SUSPENSION

D101471-

base number _____
 Finish Options _____

- To build a product code in our configurator select the specify button on the base model # product page
- To build a manual product code on this datasheet choose from the options listed below in blue font and add the suffix to the base model #

GENERAL

Series: Match
 Subseries: Match 5 Light
 Brand: Quasar
 Division: Design
 Mounting Type: Suspension
 Mounting Location: Ceiling
 Subcategory: Pendant

PHYSICAL

Shape: Rectangle
 Length (mm): 1200
 Length (in): 47 3/4
 Width (mm): 80
 Width (in): 3 1/8
 Height (mm): 63
 Height (in): 2 1/2
 Max. Overall Height (mm): 2063
 Max. Overall Height (in): 81 1/4
 Light Distribution: Downlight
 Weight (kg): 4
 Weight (lbs): 8.82
 Diffuser: Acrylic - See Finish Options
 Fixture Finish: RED / ORG / YEL / GRN / LBL / TRA
 Fixture Material: Aluminum
 Cable Details: 2000mm Cable

ELECTRICAL

Lamp Type: LED
 Input Wattage (W): 20
 Total Output Wattage (W): 15.5
 Dimming: Phase Dimming (120Vac Only)
 Driver Included: Yes
 Driver Location: Integrated
 Driver Type: Constant Current - Universal
 Driver Class: Class 2
 Input Voltage (V): 120 - 277
 Constant Current (MA): 350
 Upon Request: (Not included - see components) Integral: Phase dimming @120Vac only

LED

Number of LEDs: 5
 Color Temperature (°K): 2700
 Max. Delivered Lumen (lm): 1375
 CRI: >90 CRI
 Lamp Life (hrs): 50000

OPTICAL

RATINGS AND CERTIFICATIONS

Certified By: Certified for North American Standards
 IP rating: IP20

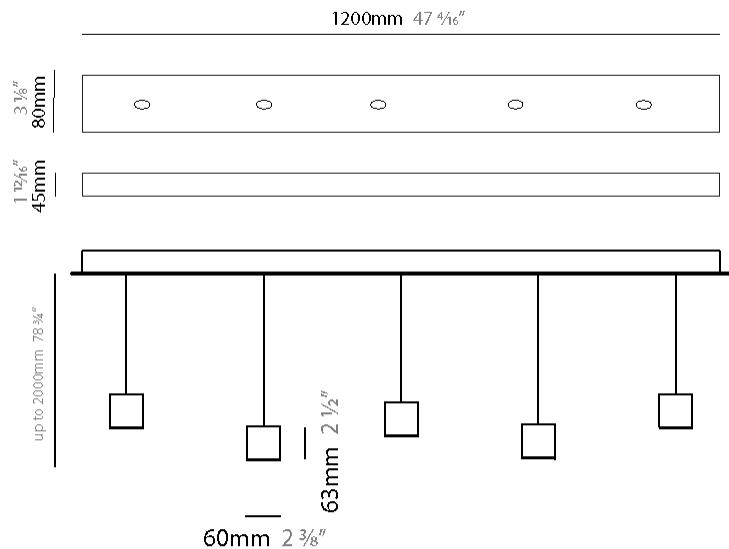

MATCH 5 LIGHT SUSPENSION

D101471-

PROJECT _____

TYPE _____

SPECIFIER _____

QUANTITY _____

DATE _____



D

MATCH 6 LIGHT SUSPENSION

D101472-

base number _____
 Finish Options _____

- To build a product code in our configurator select the specify button on the base model # product page
- To build a manual product code on this datasheet choose from the options listed below in blue font and add the suffix to the base model #

GENERAL

Series: Match
 Subseries: Match 6 Light
 Brand: Quasar
 Division: Design
 Mounting Type: Suspension
 Mounting Location: Ceiling
 Subcategory: Pendant

PHYSICAL

Shape: Rectangle
 Length (mm): 1200
 Length (in): 47 1/4
 Width (mm): 80
 Width (in): 3 1/8
 Height (mm): 63
 Height (in): 2 1/2
 Max. Overall Height (mm): 2063
 Max. Overall Height (in): 81 1/4
 Light Distribution: Downlight
 Weight (kg): 4
 Weight (lbs): 8.82
 Diffuser: Acrylic - See Finish Options
 Fixture Finish: RED / ORG / YEL / GRN / LBL / TRA
 Fixture Material: Aluminum
 Cable Details: 2000mm Cable

ELECTRICAL

Lamp Type: LED
 Input Wattage (W): 24
 Total Output Wattage (W): 18.6
 Dimming: Phase Dimming (120Vac Only)
 Driver Included: Yes
 Driver Location: Integrated
 Driver Type: Constant Current - Universal
 Driver Class: Class 2
 Input Voltage (V): 120 - 277
 Constant Current (MA): 350
 Upon Request: (Not included - see components) Integral: Phase dimming @120Vac only

LED

Number of LEDs: 6
 Color Temperature (°K): 2700
 Max. Delivered Lumen (lm): 1650
 CRI: >90 CRI
 Lamp Life (hrs): 50000

OPTICAL

RATINGS AND CERTIFICATIONS

Certified By: Certified for North American Standards
 IP rating: IP20



MATCH 6 LIGHT SUSPENSION

D101472-

PROJECT	_____
TYPE	_____
SPECIFIER	_____
QUANTITY	_____
DATE	_____

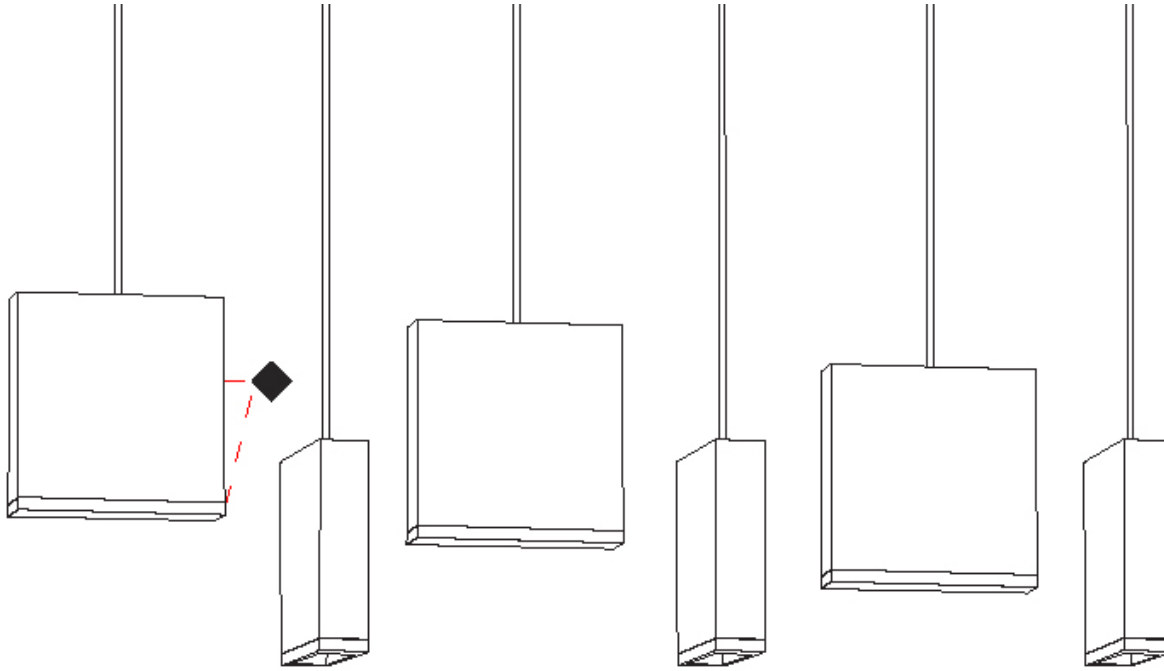

D

MATCH 7 LIGHT SUSPENSION

D101473-

base number _____
 Finish Options _____

- To build a product code in our configurator select the specify button on the base model # product page
- To build a manual product code on this datasheet choose from the options listed below in blue font and add the suffix to the base model #

GENERAL

Series: Match
 Subseries: Match 7 Light
 Brand: Quasar
 Division: Design
 Mounting Type: Suspension
 Mounting Location: Ceiling
 Subcategory: Pendant

PHYSICAL

Shape: Rectangle
 Length (mm): 1400
 Length (in): 55 1/8"
 Width (mm): 80
 Width (in): 3 1/8"
 Height (mm): 63
 Height (in): 2 1/2"
 Max. Overall Height (mm): 2063
 Max. Overall Height (in): 81 1/4"
 Light Distribution: Downlight
 Weight (kg): 5
 Weight (lbs): 11.02
 Diffuser: Acrylic - See Finish Options
 Fixture Finish: RED / ORG / YEL / GRN / LBL / TRA
 Fixture Material: Aluminum
 Cable Details: 2000mm Cable

ELECTRICAL

Lamp Type: LED
 Input Wattage (W): 28
 Total Output Wattage (W): 21.7
 Dimming: Phase Dimming (120Vac Only)
 Driver Included: Yes
 Driver Location: Integrated
 Driver Type: Constant Current - Universal
 Driver Class: Class 2
 Input Voltage (V): 120 - 277
 Constant Current (MA): 350
 Upon Request: (Not included - see components) Integral: Phase dimming @120Vac only [Class 1]

LED

Number of LEDs: 7
 Color Temperature (°K): 2700
 Max. Delivered Lumen (lm): 1925
 CRI: >90 CRI
 Lamp Life (hrs): 50000

OPTICAL

RATINGS AND CERTIFICATIONS

Certified By: Certified for North American Standards
 IP rating: IP20



MATCH 7 LIGHT SUSPENSION

D101473-

PROJECT	_____
TYPE	_____
SPECIFIER	_____
QUANTITY	_____
DATE	_____

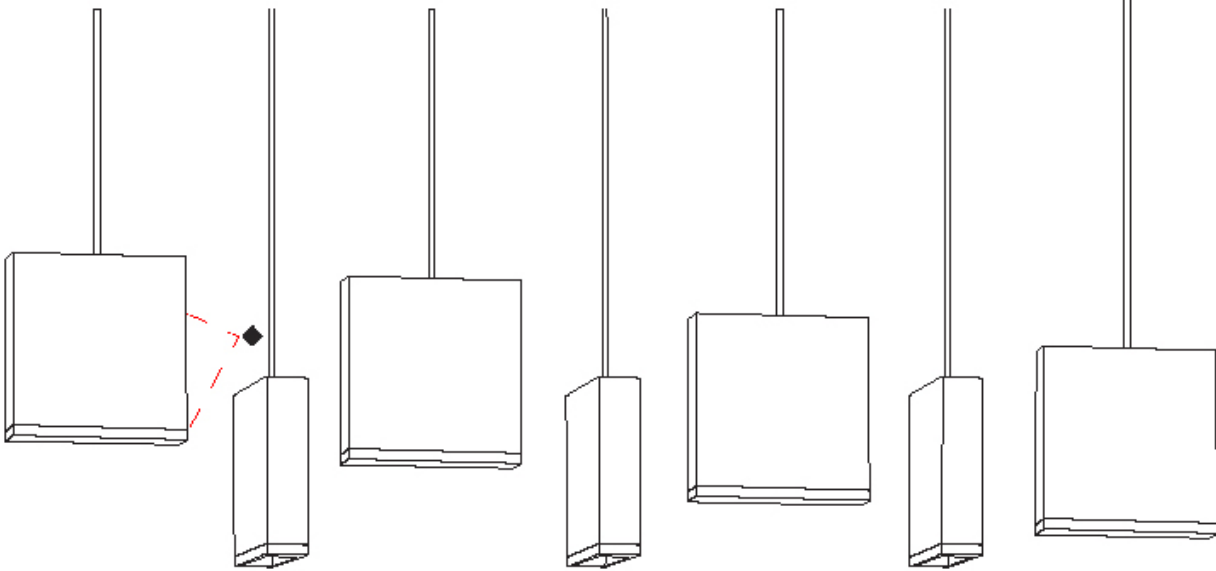

PROJECT	
TYPE	
SPECIFIER	
QUANTITY	
DATE	

MATCH SINGLE STANDARD SUSPENSION

D101618-

base number Finish
Options

- To build a product code in our configurator select the specify button on the base model # product page
- To build a manual product code on this datasheet choose from the options listed below in blue font and add the suffix to the base model #

GENERAL

Series: Match
 Subseries: Match Single Standard
 Brand: Quasar
 Division: Design
 Mounting Type: Suspension
 Mounting Location: Ceiling
 Subcategory: Pendant

PHYSICAL

Shape: Rectangle
 Length (mm): 60
 Length (in): 2 3/8
 Height (mm): 63
 Height (in): 2 1/2
 Max. Overall Height (mm): 2063
 Max. Overall Height (in): 81 1/4
 Light Distribution: Downlight
 Weight (kg): 1
 Weight (lbs): 2.2
 Diffuser: Acrylic – See Finish Options
 Fixture Finish: RED / ORG / YEL / GRN / LBL / TRA
 Fixture Material: Aluminum
 Cable Details: 2000mm Cable

ELECTRICAL

Lamp Type: LED
 Input Wattage (W): 4
 Total Output Wattage (W): 3.1
 Dimming: Phase Dimming (120Vac Only)
 Driver Included: Yes
 Driver Location: Integrated
 Driver Type: Constant Current - 120Vac
 Driver Class: Class 2
 Input Voltage (V): 120 - 277
 Constant Current (mA): 350
 Upon Request: (Not included - see components) Integral: Phase dimming @120Vac only / Non-dimming @277Vac

LED

Color Temperature (°K): 2700
 Max. Delivered Lumen (lm): 275
 CRI: >90 CRI
 Lamp Life (hrs): 50000

OPTICAL

RATINGS AND CERTIFICATIONS

Certified By: Certified for North American Standards
 IP rating: IP20



MATCH SINGLE STANDARD SUSPENSION

D101618-

PROJECT
TYPE
SPECIFIER
QUANTITY
DATE



D

PROJECT
TYPE
SPECIFIER
QUANTITY
DATE

MATCH 2 LIGHT SURFACE

D103106-

base number Finish
Options

- To build a product code in our configurator select the specify button on the base model # product page
- To build a manual product code on this datasheet choose from the options listed below in blue font and add the suffix to the base model #

GENERAL

Series: Match
 Subseries: Match 2 Light
 Brand: Quasar
 Division: Design
 Mounting Type: Surface
 Mounting Location: Wall
 Subcategory: Wall Effect

PHYSICAL

Shape: Rectangle
 Length (mm): 210
 Length (in): 8 ¼
 Height (mm): 66
 Height (in): 2 ⅝
 Extension (mm): 90
 Extension (in): 3 ⅞
 Light Distribution: Uplight
 Weight (kg): 2
 Weight (lbs): 4.41
 Diffuser: Acrylic – See Finish Options
 Fixture Finish: [RED](#) / [ORG](#) / [YEL](#) / [GRN](#) / [LBL](#) / [TRA](#)
 Fixture Material: Aluminum

ELECTRICAL

Lamp Type: LED
 Input Wattage (W): 8
 Total Output Wattage (W): 6.2
 Dimming: Phase Dimming (120Vac Only)
 Driver Included: Yes
 Driver Location: Integrated
 Driver Type: Constant Current - 120Vac
 Driver Class: Class 2
 Input Voltage (V): 120 - 277
 Constant Current (MA): 350
 Upon Request: (Not included - see components) Integral: Non-dimming 277Vac / Remote: Phase dimming @120Vac only

LED

Number of LEDs: 2
 Color Temperature (°K): 2700
 Max. Delivered Lumen (lm): 550
 CRI: >90 CRI
 Lamp Life (hrs): 50000

OPTICAL

RATINGS AND CERTIFICATIONS

Certified By: Certified for North American Standards
 IP rating: IP20

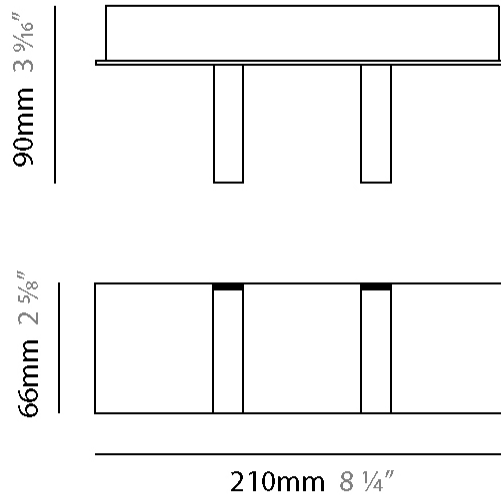

MATCH 2 LIGHT SURFACE

D103106-

PROJECT	_____
TYPE	_____
SPECIFIER	_____
QUANTITY	_____
DATE	_____

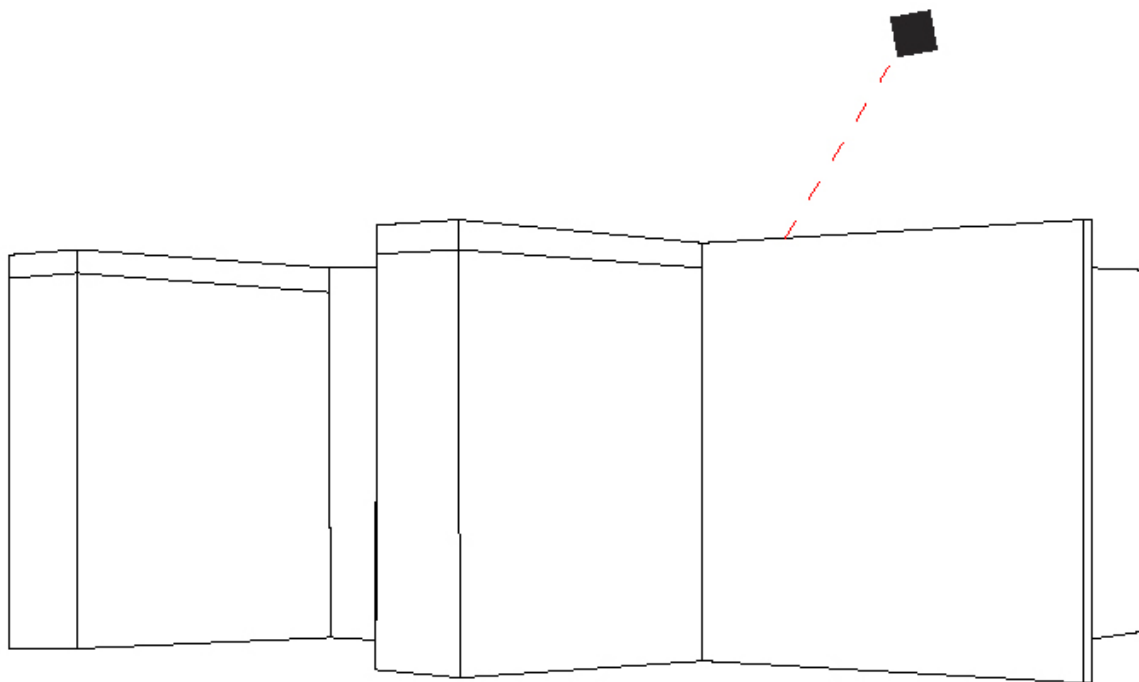

MATCH COLOR FINISH CHART

PROJECT	_____
TYPE	_____
SPECIFIER	_____
QUANTITY	_____
DATE	_____

Fixture Finish

Red - RED



Orange - ORG



Yellow - YEL



Green - GRN



Light Blue - LBL



Transparent - TRA



Digital: Not all screens are calibrated the same, and therefore, colors will appear differently between screens.

Physical: When texture is involved, there will be variations in color, character and tone within a product series and between product families.



MATCH











LEGEND

	floor-mounted		pivotal		special LED (upon request) RGB, RGBW, tunable, gold+, meat+, art+, fashion+
	wall and ceiling: recessed and surface mounted		rotating		warm dim / natural dimming LED
	ceiling-mounted and wall-mounted		illuminate tilted		rechargeable battery powered
	wall-mounted		color of suspension cable		fixture with natural vivid LED (upon request)
	omni-directional light distribution		length of suspension cable		color rendering index
	direct light distribution		reflector degree selection		color temperature
	direct/indirect light distribution		super spot		lumen (luminous flux)
	indirect light distribution		lens		efficacy (lumens per watt)
	asymmetric light distribution		lens pack		Unified Glare Rating (UGR) range from 5-40
	aura light distribution		shine ring		marine grade (AISI 316 stainless steel)
	round wall or ceiling cut-out		integrated shine ring with diffuser		walk on
	square wall or ceiling cut-out		free individual colors 01-29		drive on
	the supplied jig specifies the cutout dimensions		individual colors: 00 (free of charge), 01-25 (extra charge)		Dark Sky Compliance
	minimum distance (meters) lamp - object		luminaire part to be colored (F1)		Americans with Disabilities Act (less than 4" off the wall located between 27"-84" from floor)
	recessed depth		luminaire part to be colored (F2)		lamp protected against explosion
	ceiling thickness in mm		luminaire part to be colored (F3)		blown glass using traditional methods by master glass blower
	ceiling thickness selection		luminaire part to be colored (F4)		acoustic material
	dimmable DP (phase), DV (0-10V), DD (dali), DS (step-dim)		luminaire part to be colored (F5)		protection class I, protection insulation
	included or excluded LED driver/transformer/control gear		color of 3-circuit adaptor		protection class II, protection insulation
	separately switchable		indirect diffuser		ETL Certified to UL and CSA Standards
	sensor		direct diffuser		UL Certified to UL and CSA Standards
	remote control		ball-proof (upon request)		CSA Certified to UL and CSA Standards
	available upon request		accessory		Certified for North American Standards

IP RATING

	protected against ingress of solid bodies greater than 12.5mm (finger)
	protected against ingress of solid bodies greater than 2.5mm protected against sprays of water up to 60 degrees from the vertical (rain)
	protected against ingress of solid bodies greater than 1mm (wire) no protection against the ingress of moisture
	protected against ingress of solid bodies greater than 1mm (wire) protected against sprays of water up to 60 degrees from the vertical (rain)
	protected against ingress of solid bodies greater than 1mm (wire) protected against water splashed from all directions
	protected against limited ingress of dust (wet rooms/covered outdoor areas) protected against water splashed from all directions
	protected against ingress of dust protected against jets of water
	protected against ingress of dust protected against powerful jets of water or heavy seas
	protected against ingress of dust protected against immersion of water between 15cm - 1m for 30 minutes
	protected against ingress of dust protected against immersion of water under pressure for long periods

IK RATING

	protected against 0.14 joules impact (equivalent to 0.25kg mass dropped from 56mm above the surface)
	protected against 0.2 joules impact (equivalent to 0.25kg mass dropped from 80mm above the surface)
	protected against 0.35 joules impact (equivalent to 0.25kg mass dropped from 140mm above the surface)
	protected against 0.5 joules impact (equivalent to 0.25kg mass dropped from 200mm above the surface)
	protected against 0.7 joules impact (equivalent to 0.25kg mass dropped from 280mm above the surface)
	protected against 1 joules impact (equivalent to 0.25kg mass dropped from 400mm above the surface)
	protected against 2 joules impact (equivalent to 0.5kg mass dropped from 400mm above the surface)
	protected against 5 joules impact (equivalent to 1.7kg mass dropped from 300mm above the surface)
	protected against 10 joules impact (equivalent to 5.0kg mass dropped from 200mm above the surface)
	protected against 20 joules impact (equivalent to 5.0kg mass dropped from 400mm above the surface)